

 **VISENTIN**  
ITALIAN LUXURY BATHROOM



  
ice light

**GIOIELLI**  
COLLECTION

# ice light



## cromoterapia / colourtherapy

Dal punto di vista terapeutico (trattamento di disturbi relativi al nostro organismo), la cromoterapia è considerata una "terapia dolce" in quanto non è invasiva, generalmente non presenta particolari effetti collaterali e fornisce immediatamente un effetto benefico a chi si sottopone ad un trattamento. I colori sono forza vitale e fonte di energia, il bagno diventa il luogo ideale per irradiazioni con fasci di luce colorata, perchè sono in grado di stimolare la formazione delle cellule del corpo e influire su nervi e organi in modo benefico. Una doccia di colori e di luce per un determinato periodo di tempo su tutto il corpo determina una completa rigenerazione cellulare.

*Therapeutically, the colourtherapy is considered a "sweet therapy" since it is not invasive, and does not present any collateral unwanted effects, its benefits are immediate for those who chose to use it. Colours are a vital force and an energy source.*

*Bathroom is an ideal space for therapies of coloured light since the colourtherapy is able to stimulate the formation of new cells and influence the nerve system and organs in a beneficial way.*

*A shower of colours and light for a certain period of time all the body is able to determine a complete regeneration of cells.*

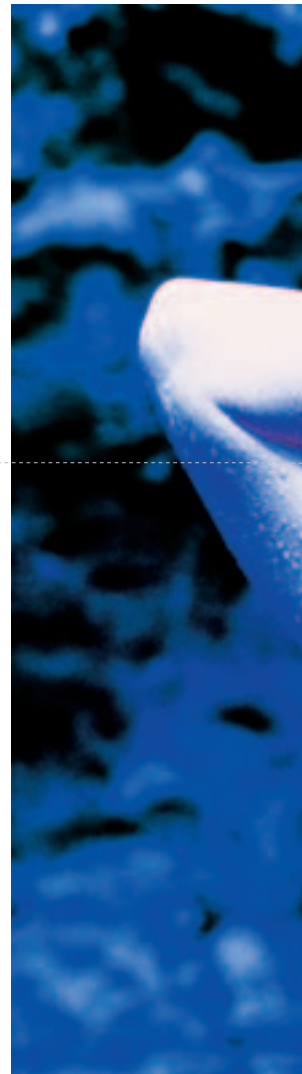

rosso vita   arancione energia   giallo intelletto   verde armonia amore simpatia  
*redlife   orangeenergy   yellowintellect   greenharmony love sympathy*



blucreatività comunicazione

*bluecreativity communication*

indaco intuizione

*indigo intuition*

violette spiritualità

*violet spirituality*

ice light

interpretato da Marcello Ziliani





## luminose trasparenze / *bright transparencies*

Ogni oggetto potrebbe essere narrato attraverso la luce che lo percorre, perchè è nei tratti, nelle trasparenze, nelle ombre che la luce genera un'emozione. Così semplici dettagli possono diventare frammenti scintillanti di un prezioso gioiello.

La luce è in questo viaggio elemento di rappresentazione della bellezza

*Every object is defined by the light which sculpts its lines, shadows, transparencies creating the emotions it reflects back to us.*

*This is how we created simple details which have become sparkling fragments of a jewel.*

*We have used the light as an artist to create beauty*

*played by Marcello Ziliani*

ice light

luminose trasparenze / *bright transparencies*

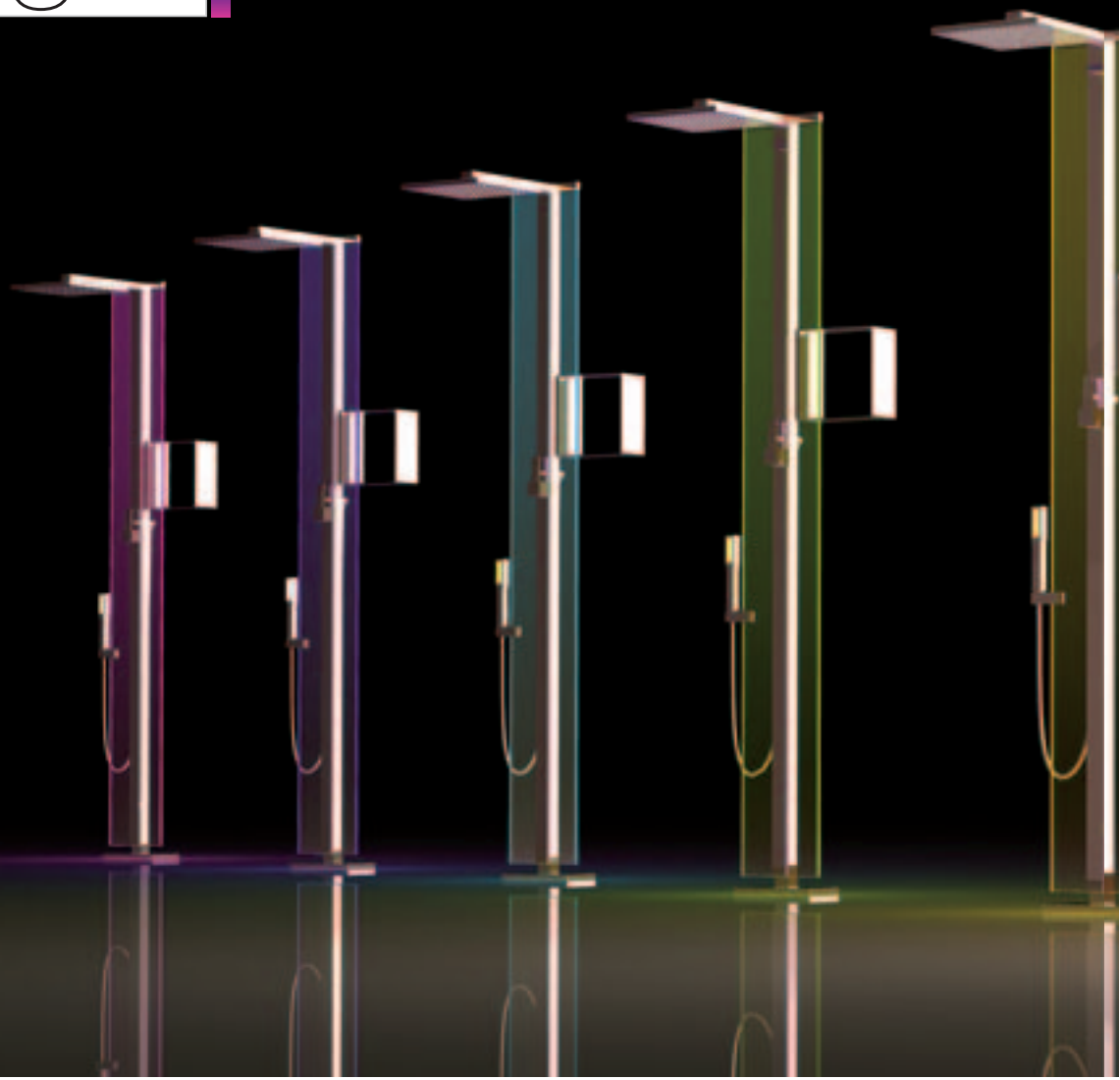

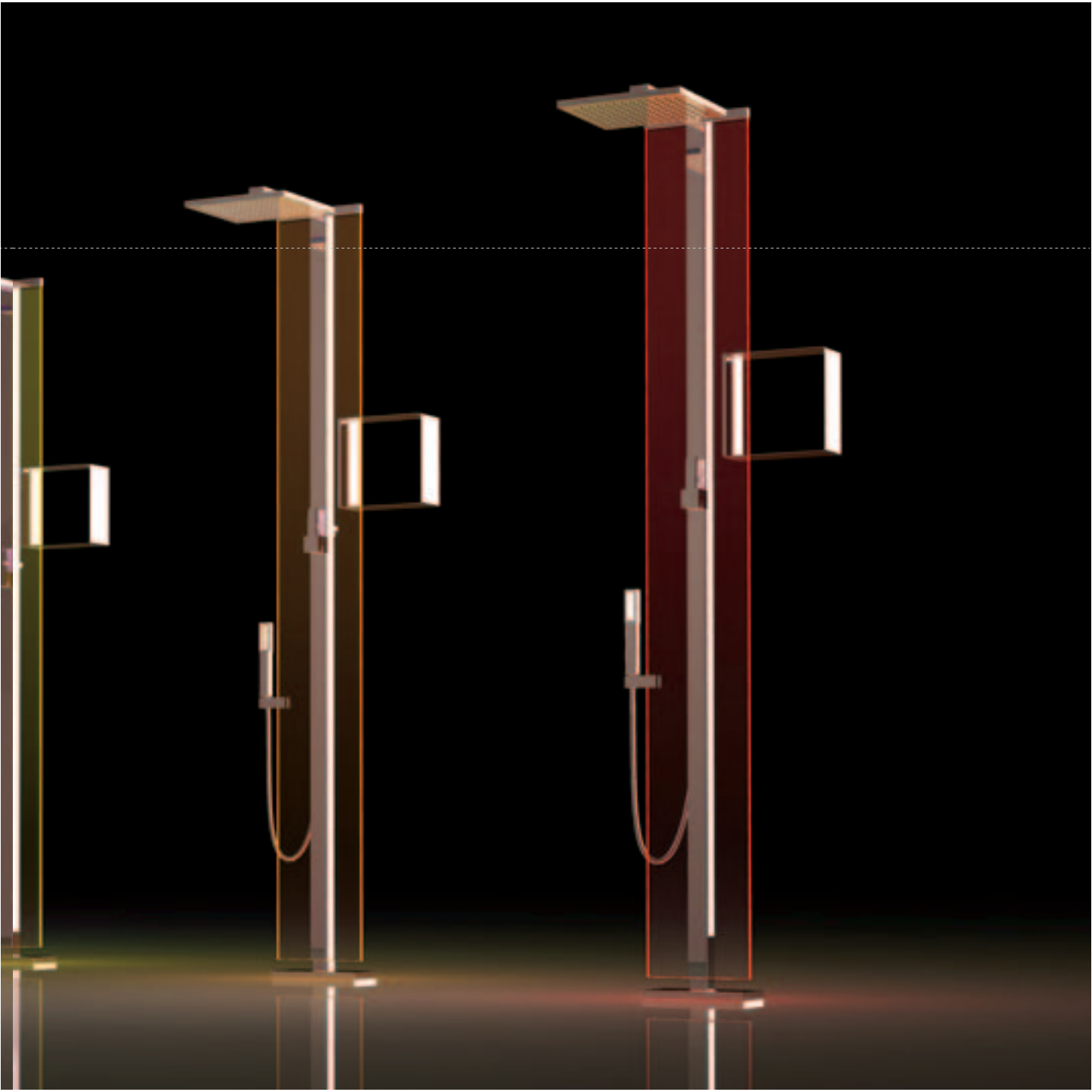

# ice light

l  
i  
g  
h  
t

Per un ambiente bagno sempre in sintonia le colonne doccia ed i soffioni ICE LIGHT creano terapie colore CALDE, FREDDI e RILASSANTI, dispongono di un comando a distanza per l'accensione/spengimento e regolazione delle luci

Each ICE LIGHT shower column and showerhead comes complete with a remote control which allows you to custom create a colourtherapy program by using WARM, COOL, and RELAXING colours to maximize harmony and ambiance in your bath

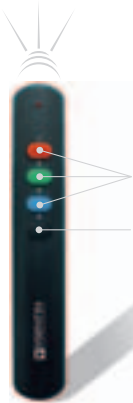

Sceita tonalità colore  
*Choosing the tonality of colour*

Accensione/Spengimento Luci  
Sceita modalità sequenziale o colore fisso  
*Turning the lights on and off  
Choosing the sequential mode or fixed colour*

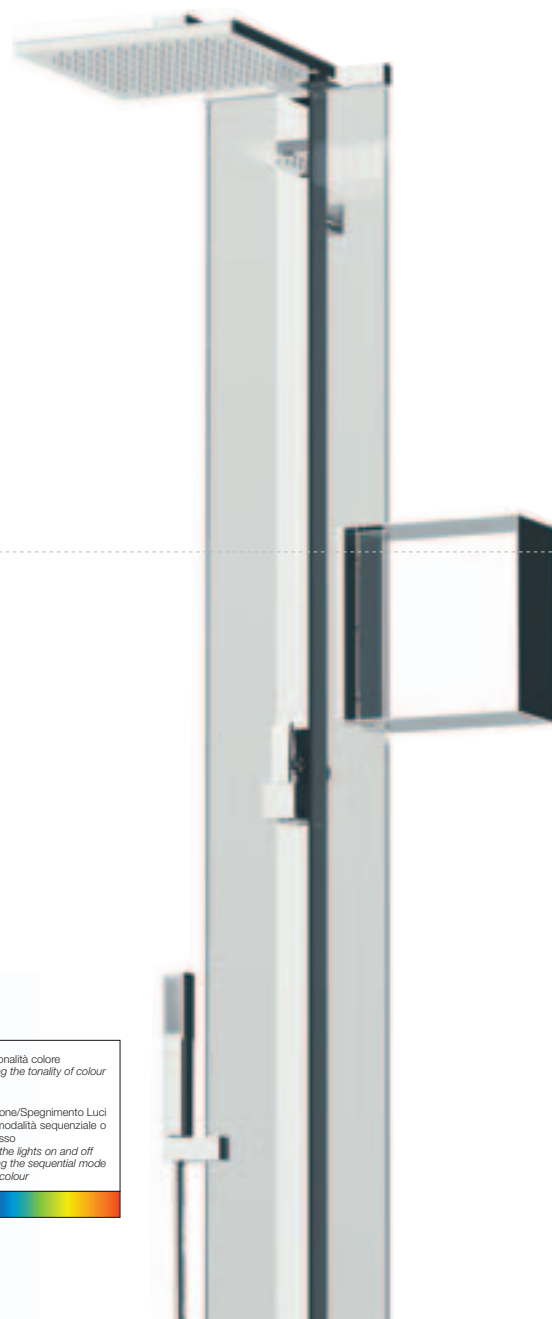



l i g h t

**CDI01LGCR**  
 Colonna doccia a pavimento  
 soffione 300x300 mm  
 controllo luci  
 con comando a distanza  
*Shower column for floor  
 installation with Shower  
 head 300x300 mm  
 remote control  
 for colourtherapy*



l i g h t

**CDI02LGCR**  
 Colonna doccia a muro  
 soffione 300x300 mm  
 controllo luci  
 con comando a distanza  
*Shower column for wall  
 installation with Shower  
 head 300x300 mm  
 remote control  
 for colourtherapy*





l i g h t

**CDI03LGCR**  
 Colonna doccia a muro  
 soffione 300x300 mm  
 controllo luci  
 con comando a distanza  
*Shower column for wall  
 installation with Shower  
 head 300x300 mm  
 remote control  
 for colourtherapy*

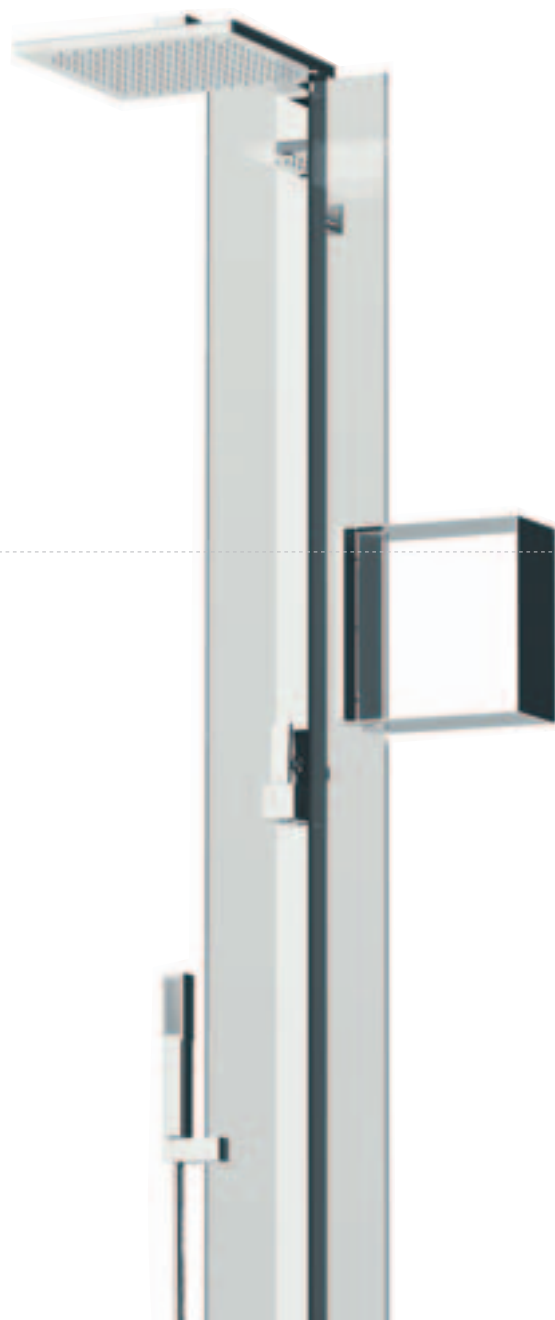

ice light transparent



**CDI01CR**

Colonna doccia a pavimento  
soffione 300x300 mm  
Shower column for floor  
installation with Shower  
head 300x300 mm

**CDI02CR**

Colonna doccia a muro  
soffione 300x300 mm  
Shower column for wall  
installation with Shower  
head 300x300 mm

**CDI03CR**

Colonna doccia a muro  
soffione 300x300 mm  
Shower column for wall  
installation with Shower  
head 300x300 mm



ice light white

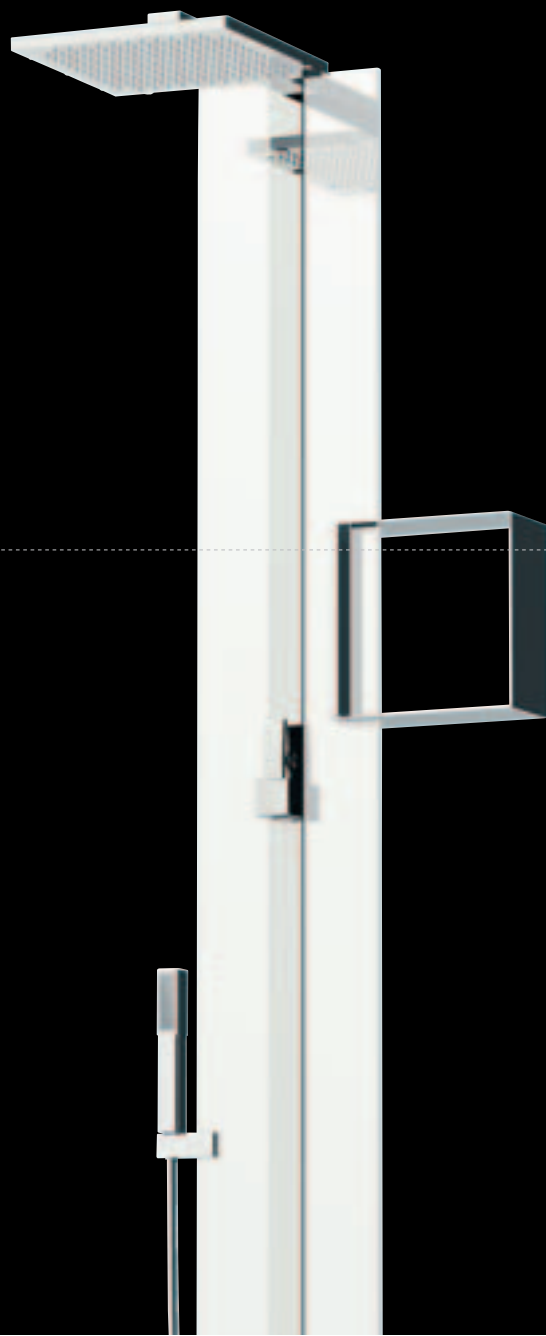

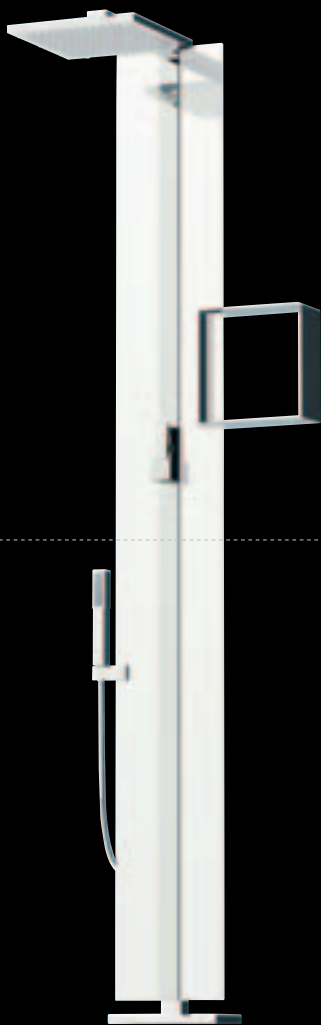
**CDI01BICR**

Colonna doccia a pavimento  
soffione 300x300 mm  
Shower column for floor  
installation with Shower  
head 300x300 mm

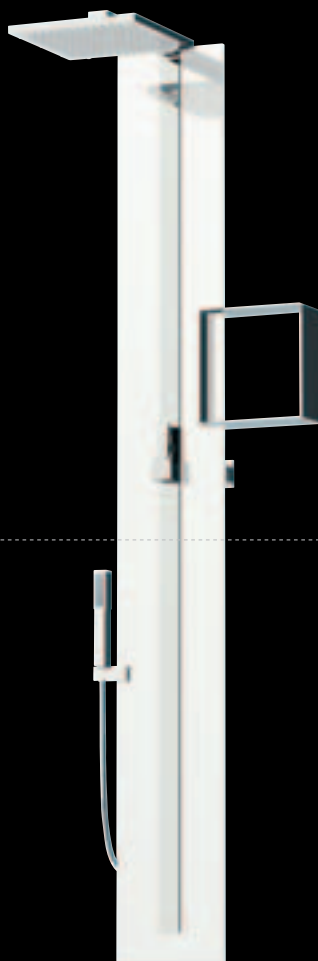
**CDI02BICR**

Colonna doccia a muro  
soffione 300x300 mm  
Shower column for wall  
installation with Shower  
head 300x300 mm

**CDI03BICR**

Colonna doccia a muro  
soffione 300x300 mm  
Shower column for wall  
installation with Shower  
head 300x300 mm



ice light  
black



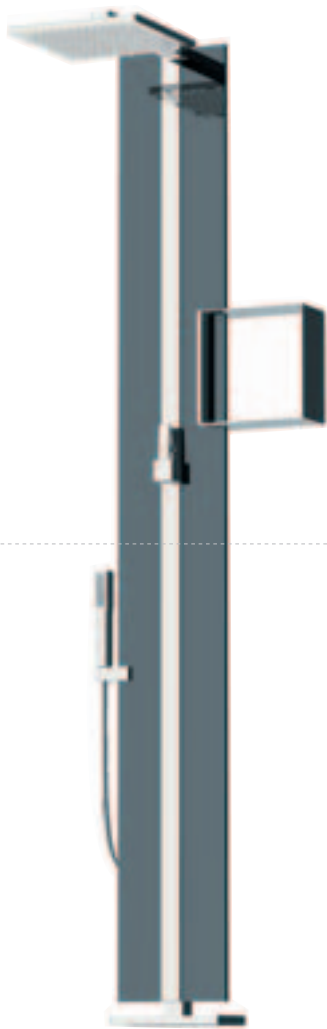

**CDI01NECR**  
Colonna doccia a pavimento  
soffione 300x300 mm  
Shower column for floor  
installation with Shower  
head 300x300 mm

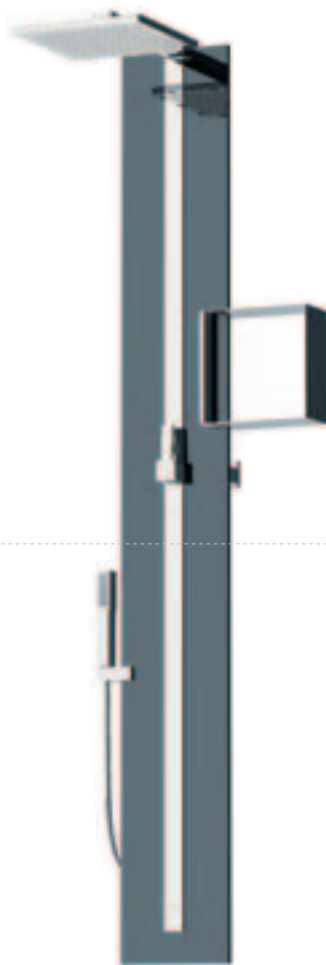

**CDI02NECR**  
Colonna doccia a muro  
soffione 300x300 mm  
Shower column for wall  
installation with Shower  
head 300x300 mm

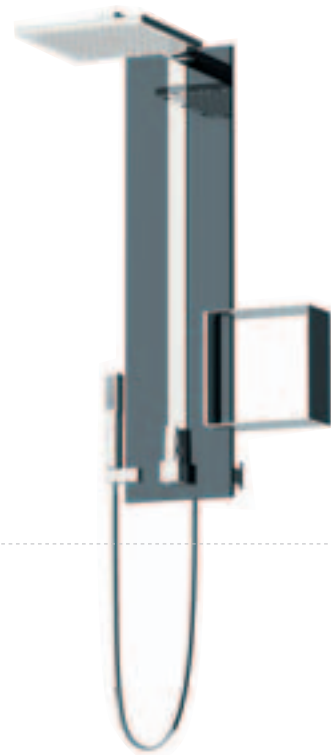

**CDI03NECR**  
Colonna doccia a muro  
soffione 300x300 mm  
Shower column for wall  
installation with Shower  
head 300x300 mm



ice light

luminose trasparenze / *bright transparencies*

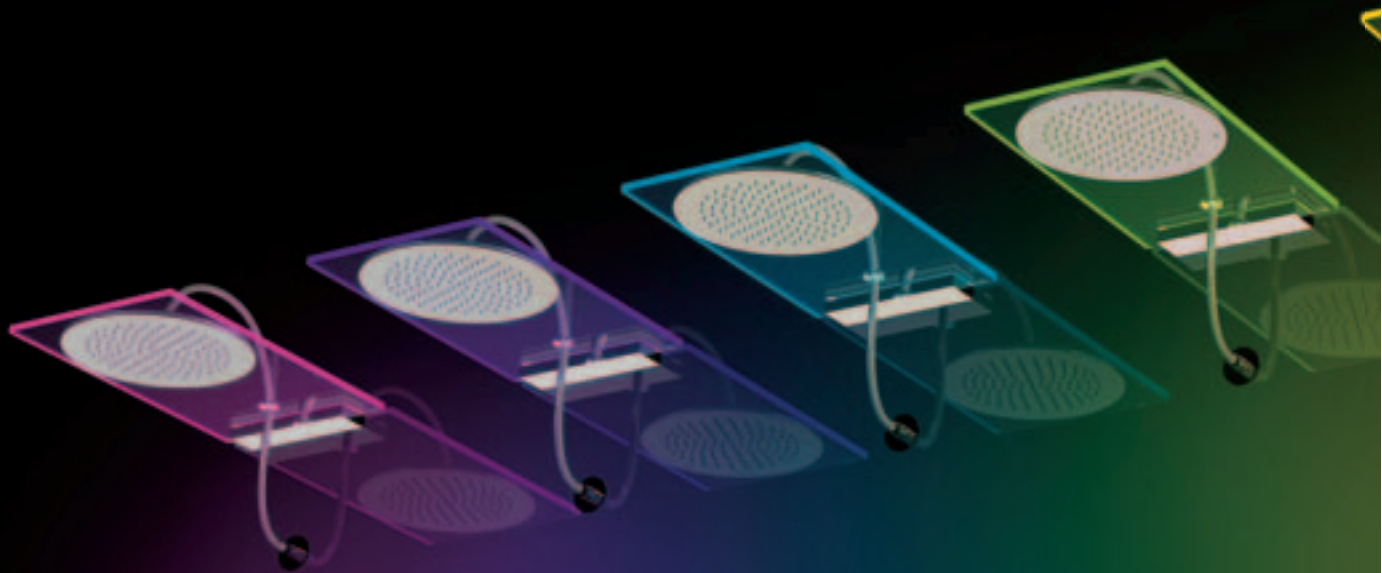



l i g h t

Per un ambiente bagno sempre in sintonia le colonne doccia ed i soffioni ICE LIGHT creano terapie colore CALDE, FREDDI e RILASSANTI, dispongono di un comando a distanza per l'accensione/spengimento e regolazione delle luci

Each ICE LIGHT shower column and showerhead comes complete with a remote control which allows you to custom create a colourtherapy program by using WARM, COOL, and RELAXING colours to maximize harmony and ambiance in your bath

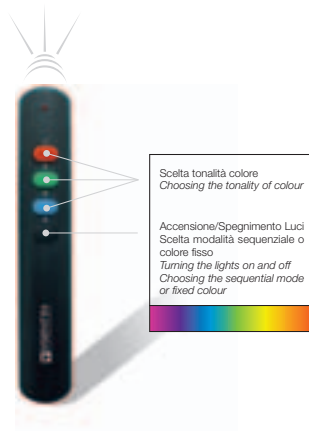
# ice light



luminose trasparenze / bright transparencies



l i g h t

**SOFDX128LGCR**  
Soffione a muro Ø 300 mm  
con presa acqua e  
controllo luci  
con comando a distanza  
Wall mount shower head  
Ø 300 mm  
with water inlet  
remote control for  
colourtherapy



l i g h t

**SOFDX126LGCR**  
Soffione a muro Ø 200 mm  
con presa acqua e  
controllo luci  
con comando a distanza  
Wall mount shower head  
Ø 200 mm with  
water inlet  
remote control for  
colourtherapy





**SOFDX129LGCR**

Soffione a muro  
300x300 mm con presa  
acqua e controllo luci  
con comando a distanza  
Wall mount shower head

300x300 mm  
with water inlet  
remote control for  
colourtherapy



**SOFDX127LGCR**

Soffione a muro  
200x200 mm con presa  
acqua e controllo luci  
con comando a distanza  
Wall mount shower head

200x200 mm  
with water inlet  
remote control for  
colourtherapy



# ice light

transparent

luminose trasparenze / *bright transparencies*



## **SOFDX128CR**

Soffione a muro Ø 300 mm

con presa acqua  
Wall mount shower  
head Ø 300 mm with  
water inlet



## **SOFDX126CR**

Soffione a muro Ø 200 mm

con presa acqua  
Wall mount shower  
head Ø 200 mm with  
water inlet





**SOFDX129CR**

Soffione a muro 300x300 mm  
con presa acqua  
Wall mount shower  
head 300x300 mm  
with water inlet



**SOFDX127CR**

Soffione a muro 200x200 mm  
con presa acqua  
Wall mount shower  
head 200x200 mm  
with water inlet



ice light

w h i t e

luminose trasparenze / *bright transparencies*



**SOFDX128BICR**

Soffione a muro Ø 300 mm

con presa acqua  
Wall mount shower  
head Ø 300 mm with  
water inlet



**SOFDX126BICR**

Soffione a muro Ø 200 mm

con presa acqua  
Wall mount shower  
head Ø 200 mm with  
water inlet





**SOFDX129BICR**

Soffione a muro 300x300 mm  
con presa acqua  
Wall mount shower  
head 300x300 mm  
with water inlet



**SOFDX127BICR**

Soffione a muro 200x200 mm  
con presa acqua  
Wall mount shower  
head 200x200 mm  
with water inlet



# ice light

b | a | c | k

luminose trasparenze / *bright transparencies*



## **SOFDX128NECR**

Soffione a muro Ø 300 mm  
con presa acqua  
Wall mount shower  
head Ø 300 mm with  
water inlet



## **SOFDX126NECR**

Soffione a muro Ø 200 mm  
con presa acqua  
Wall mount shower  
head Ø 200 mm with  
water inlet





**SOFDX129NECR**

Soffione a muro 300x300 mm  
con presa acqua  
*Wall mount shower  
head 300x300 mm  
with water inlet*



**SOFDX127NECR**

Soffione a muro 200x200 mm  
con presa acqua  
*Wall mount shower  
head 200x200 mm  
with water inlet*



## SIMBOLI-SYMBOLS / CERTIFICAZIONI-CERTIFICATIONS



La ricerca tecnologica applicata alla soluzione del problema del calcare. Tutte le docce Visentin, utilizzano speciali ugelli in gomma **Self Cleaning**® che facilitano la rimozione del calcare. Inoltre le cartucce multifunzione sono ispezionabili. *Technological research applied to solving the problem of limescale accumulation. All Visentin showers use the **Self Cleaning**® device, a special TPR (thermo plastic rubber) which facilitates limescale removal, all impurities are removed by simply wiping the nozzles with your fingers while the water flow is turned on.*



**Full**  
Un getto ampio ed avvolgente  
*An all embracing wide and powerful spray*



**Normal**  
Un getto pieno e corposo  
*A comfortable broad spray*



**Variable**  
Un getto Normal più ampio e intenso  
*A normal spray that is even wider and stronger*



**Eco**  
Un uscita del getto ridotta per un risparmio d'acqua fino al 50%  
*A reduced spray to save water up to 50%*



**Soft**  
Un getto d'acqua e aria combinati per una morbida sensazione sulla pelle  
*A spray of air and water combined for a soft touch on the skin*



**Sport**  
Un getto tonificante  
*A tonifying spray*



**Strong**  
Un getto molto forte di aria e acqua  
*A very strong spray of air and water*



**Massage**  
Un getto pulsante per un massaggio profondo  
*A pulsating spray for a deep massage*



**Satin**  
Un getto morbido e delicato  
*A satin-like spray*



**Soaping**  
Un getto ad effetto sgocciolo per permette un risparmio d'acqua fino al 90%  
*A misty spray to ensure water saving up to 90%*



**Solid Brass**  
Tutto Ottone  
*Solid Brass*



**Antitorison**  
Calotta girevole, impedisce l'attorcigliamento del flessibile  
*Conical nut to avoid the hose twisting*



**Flow regulator**  
All'interno di questi soffioni è inserita una speciale valvola (regolatore di portata) che garantisce un getto d'acqua omogeneo a tutte le pressioni. Pressione minima richiesta 1 bar  
*A special restrictor valve (flow regulator) has been inserted in these shower heads to ensure constant water flow in all pressures ranges. To ensure sufficient performance of this showerhead is required a minimum pressure of 1 bar (14,5 psi)*



**Double water supply**  
Nei soffioni orizzontali e laterali per ottenere un getto d'acqua omogeneo è consigliata l'alimentazione da entrambe le entrate  
*To obtain a homogeneous water flow, for horizontal and vertical shower sprays we recommend water supply from both intakes*

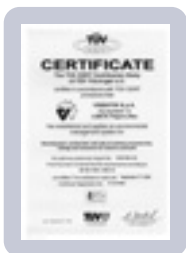

### CERTIFICAZIONE AMBIENTALE UNI EN ISO 14001

La presente norma internazionale si applica a ogni organizzazione che desideri: applicare, mantenere attivo, migliorare un sistema di gestione ambientale; assicurarsi di ottemperare alla propria stabilità politica ambientale; dimostrare tale conformità agli altri; richiedere la certificazione/registrazione del proprio sistema di gestione ambientale presso un organismo terzo; fare una auto-valutazione o una auto-dichiarazione di conformità alla presente norma internazionale.

### ENVIRONMENTAL CERTIFICATION UNI EN ISO 14001

*This international norm is applicable to any organization desiring: to implement, maintain and improve an environmental management system; to ensure a correct implementation of the company's environmental policy; to demonstrate its compliance with the policy; to apply for certification/registration of its environmental management system by an authorized independent organization; carry out a self-evaluation or make a self-declaration of compliance to the current international set of rules.*



### CERTIFICAZIONE UNI EN ISO 9001:2000

La presente norma internazionale specifica i requisiti di un sistema di gestione per la qualità quando un'organizzazione: ha l'esigenza di dimostrare la sua capacità di fornire con regolarità prodotti che ottemperino ai requisiti dei clienti ed a quelli cogenti applicabili; desidera accrescere la soddisfazione dei clienti tramite l'applicazione efficace del sistema, ivi inclusi i processi per il miglioramento continuo del sistema e l'assicurazione della conformità ai requisiti del cliente ed a quelli cogenti applicabili

### CERTIFICATION UNI EN ISO 9001:2000

*This international norm specifies the requirements of a quality control system when a company needs: to prove that the products it manufactures fully satisfy the customers' requests and comply with the applicable laws and regulations; to increase the customers' satisfaction through an adequate implementation of the system, including the development of processes aimed at the steady improvement of the products and their compliance with the customers' needs and the specifications required by law.*

Per informazioni di carattere tecnico:  
VISENTIN CUSTOMER CARE  
Tel. +39 0322 9974  
(orario 09:30 - 12:30 / 14:30 - 17:30)

Per ulteriori dettagli e informazioni su Visentin S.p.A. consultare il sito internet:  
[www.visentin.it](http://www.visentin.it)

For technical informations, please contact:  
VISENTIN CUSTOMER CARE  
Phone +39 0322 9974  
(09:30 - 12:30 / 14:30 - 17:30) local time

For any other question please visit us at:  
[www.visentin.it](http://www.visentin.it)

associato a  
**ASSOBAGNO**  
FEDERLEGNO-ARREDO

**ADI MEMBER**

 **VISENTIN**  
ITALIAN LUXURY BATHROOM

VISENTIN SPA  
VIA GARIBALDI, 15  
28076 POGNO (NO) ITALY  
TEL/PHONE +39 0322 9974  
FAX +39 0322 97116  
[www.visentini.it](http://www.visentini.it)